

C Series

Explosion Proof Light





C2



C



C3



Product Description

The C Series LED luminaire is the ideal choice for marine and hazardous applications. They can be used in locations where moisture, dirt, dust, corrosion and vibration may be present, or areas where wind, water, snow or high ambient can be expected.

Features

- 0-10V dimming
- High luminous efficacy - Up to 140 lumens per watt
- Battery backup function available
- Compact and robust structure, excellent reliability
- Various installation ways for different applications
- Great impact resistance with IK08/IK10 certified
- Copper-free aluminum housing, great corrosion resistance and cooling performance

Compliance

UL 844 Hazardous Locations
Class I Division 1, Group C, D
Class I Division 2, Group A, B, C, D
Class II Division 1, Group E, F, G
Class II Division 2, Group F, G
Class III
Class I, Zone 1, Group IIB
Class II, Zone 21, Group IIIC
UL 1598 Wet Locations
UL 1598A Marine Outside Type
UL 924 Emergency Lighting
CSA C22.2#137:2018 Ed.2
CSA C22.2#250.0:2021 Ed.5
ETL (ATM for Report 105342415DAL-001/003)
ABS
DLC*
IP66
IK08 (glass cover)
IK10 (with wire guard)
1000 hours salt spray

** Not all product variations listed on this spec sheet are DLC qualified.
Visit www.designlights.org/search to confirm qualification.*



Application

- Power Plants
- Heavy Industrials Storage Facility
- Paper mills
- Wastewater Treatment Plants
- Loading Docks Platforms
- Offshore Environments
- Chemical Processing Facility
- Petrochemical Processing Facility
- Metallurgical Industry
- Coal Mine
- Food and Alcohol industry



Warranty

5-Year Standard Warranty

LED lumen Maintenance: L70> 150,000 Operation Hours@55°C

Technical Parameter

• Electrical

Specification	EX-20W C2YZDA	EX-40W C2YZDA	EX-60W C2YZDA	EX-80W C2YZDA
Rated Power	20W	40W	60W	80W
Input Voltage	100-277/200-480VAC			
Input Frequency	50/60Hz			
Power Factor	> 0.95			
Emergency Time*	No Emergency Function			

*Emergency function optional.

• Optical

Specification	EX-20W C2YZDA	EX-40W C2YZDA	EX-60W C2YZDA	EX-80W C2YZDA
Lumen Output	2800lm	5,600lm	8,400lm	11200lm
Lumens Per Watt	140lm/W			
CCT	2700K-7000K			
CRI	> 70			
Beam Angle	40°/60°/90°/120°			
Dimming	0-10V dimming			

• Environmental

Specification	EX-20W C2YZDA	EX-40W C2YZDA	EX-60W C2YZDA	EX-80W C2YZDA
Ambient Temperature	T4: -40°C to 60°C (-40°F to 140°F)			

• Mechanical

Specification	EX-20W C2YZDA	EX-40W C2YZDA	EX-60W C2YZDA	EX-80W C2YZDA
Housing Material	Copper-free aluminum			
Diffuser	Tempered glass			
Hardware	Stainless steel			
Protection	IP66/IK08 (glass cover)/IK10 (with wire guard)			
Mounting	Ceiling, Wall, Hook, Pole, Trunnion			
Cable Entries*	Side: 3/4" NPT (standard); M20, M25, 1/2" NPT (optional) Top: 3/4" NPT (standard); M25 (optional)			

* For cable entries, 3/4" NPT is standard. Others can be achieved with an adapter, and customer needs to indicate which is required when placing an order.

Technical Parameter

• Electrical

Specification	EX-100W CYZDA	EX-150W CYZDA
Rated Power	100W	150W
Input Voltage	100-277/200-480VAC	
Input Frequency	50/60Hz	
Power Factor	> 0.95	
Emergency Time*	No Emergency Function	

*Emergency function optional.

• Optical

Specification	EX-100W CYZDA	EX-150W CYZDA
Lumen Output	14000lm	21000lm
Lumens Per Watt	140lm/W	
CCT	2700K-7000K	
CRI	> 70	
Beam Angle	40°/60°/90°/120°	
Dimming	0-10V dimming	

• Environmental

Specification	EX-100W CYZDA	EX-150W CYZDA
Ambient Temperature	T4: -40°C to 60°C (-40°F to 140°F)	

• Mechanical

Specification	EX-100W CYZDA	EX-150W CYZDA
Housing Material	Copper-free aluminum	
Diffuser	Tempered glass	
Hardware	Stainless steel	
Protection	IP66/IK08 (glass cover)/IK10 (with wire guard)	
Mounting	Ceiling, Wall, Hook, Pole	
Cable Entries*	Side: 3/4" NPT (standard); M20, M25, 1/2" NPT (optional) Top: 3/4" NPT (standard); M25 (optional)	

* For cable entries, 3/4" NPT is standard. Others can be achieved with an adapter, and customer needs to indicate which is required when placing an order.

Technical Parameter

• Electrical

Specification	EX-200W C3YZDA	EX-250W C3YZDA	EX-280W C3YZDA
Rated Power	200W	250W	280W
Input Voltage	100-277/200-480VAC		
Input Frequency	50/60Hz		
Power Factor	> 0.95		
Emergency Time*	3 hours		

*Emergency function optional.

• Optical

Specification	EX-200W C3YZDA	EX-250W C3YZDA	EX-280W C3YZDA
Lumen Output	28000lm	35000lm	39200lm
Lumens Per Watt	140lm/W		
CCT	2700K-7000K		
CRI	> 70		
Beam Angle	40°/60°/90°/120°		
Dimming	0-10V dimming		

• Environmental

Specification	EX-200W C3YZDA	EX-250W C3YZDA	EX-280W C3YZDA
Ambient Temperature	T4: -40°C to 60°C (-40°F to 140°F)		

• Mechanical

Specification	EX-200W C3YZDA	EX-250W C3YZDA	EX-280W C3YZDA
Housing Material	Copper-free aluminum		
Diffuser	Tempered glass		
Hardware	Stainless steel		
Protection	IP66/IK08 (glass cover)/IK10 (with wire guard)		
Mounting	Ceiling, Wall, Hook, Pole		
Cable Entries*	Side: 3/4" NPT (standard); M20, M25, 1/2" NPT (optional) Top: 3/4" NPT (standard); M25 (optional)		

* For cable entries, 3/4" NPT is standard. Others can be achieved with an adapter, and customer needs to indicate which is required when placing an order.

Product Dimensions Unit: mm [inch]

C2

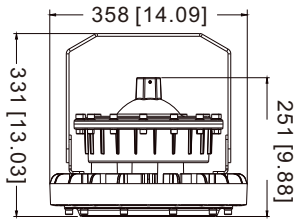

Flat glass

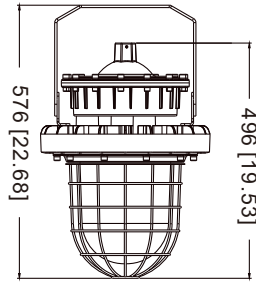

with drop lens and wire guard

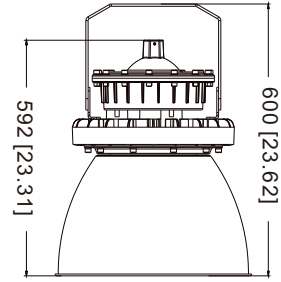

with lamp shade

C

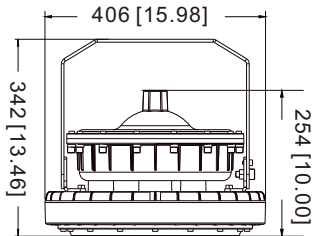

Flat glass

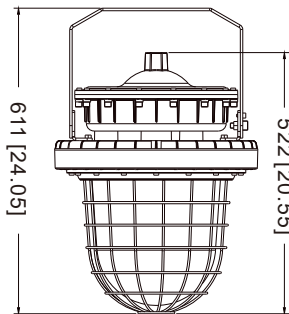

with drop lens and wire guard

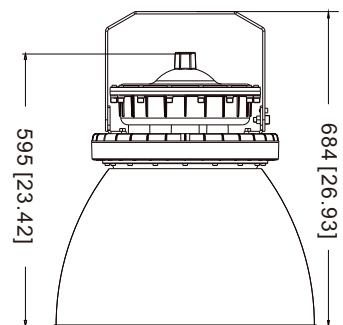

with lamp shade

C3

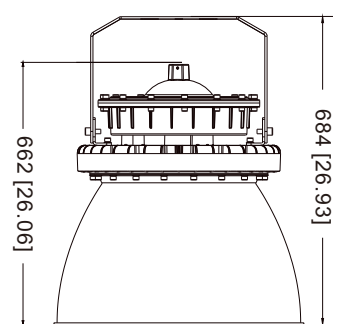
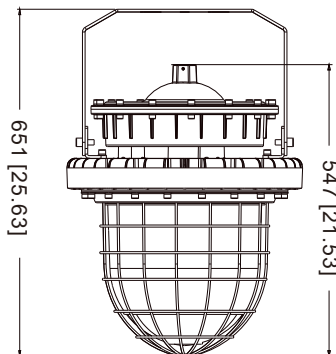
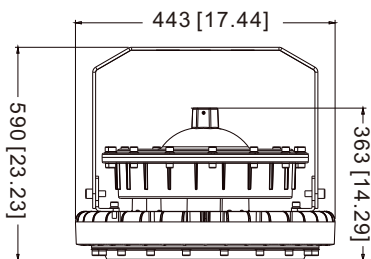

Cable Entries

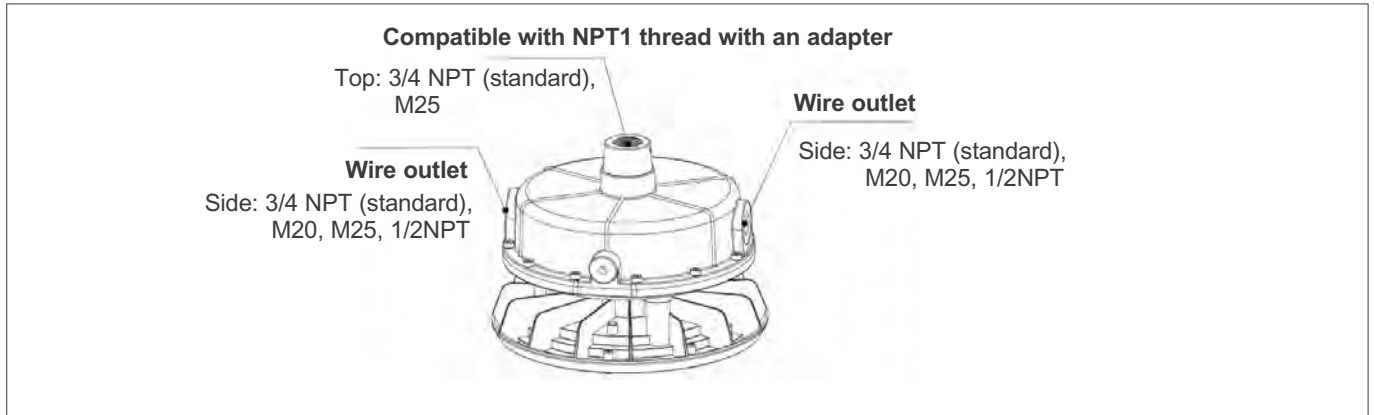

• Packing Information

Model	Net Weight*	Gross Weight*	Quantity/Carton	Package Dimensions (LxWxH)
C2	30.86 lb	35.27 lb	1 pc	18.50x18.50x13.58 inch
C	38.36 lb	41.89 lb	1 pc	21.65x20.47x14.17 inch
C3	46.30 lb	55.12 lb	1 pc	21.85x21.85x13.58 inch

*Please note that net weight and gross weight may be subject to change because of actual configuration.

Ordering Guide

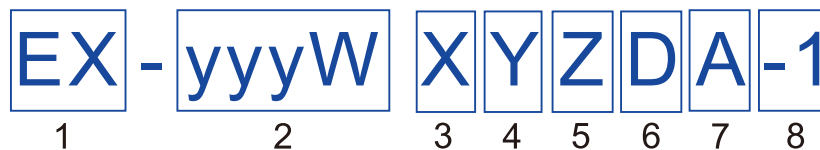

1. Product Categories	2. Wattage	3. Shell Shape Series	4. Dimming or Not
Explosion Proof Light	C2: 20/40/60/80W C: 100/150W C3: 200/250/280W	“X” Can be: C C2 C3	“Y” Can be: D: Dimmable N: Non-dimmable

5. Color Temperature	6. Beam Angle	7. Long Glass Cover Optional	8. Optional
“Z” can be 27 to 70 denotes 2700K to 7000K, and each 100K gradually increase, max 7000K	D40=40° D60=60° D90=90° D120=120°	“A” = C: long glass cover	“-1” NA (optional)

Photometric

40 Degree

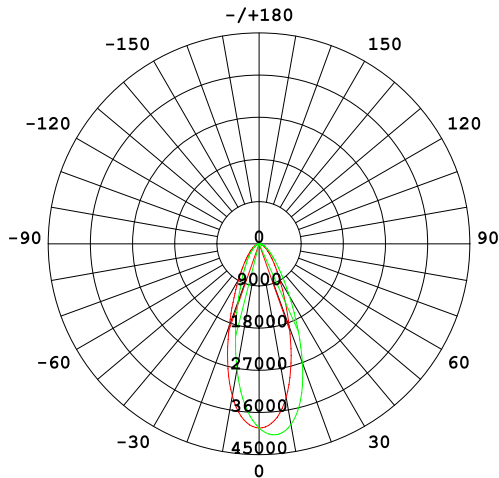

AVERAGE BEAM ANGLE(50%):38.6 DEG

UNIT:cd

- C0/180,38.7°
- C90/270,38.5°

60 Degree

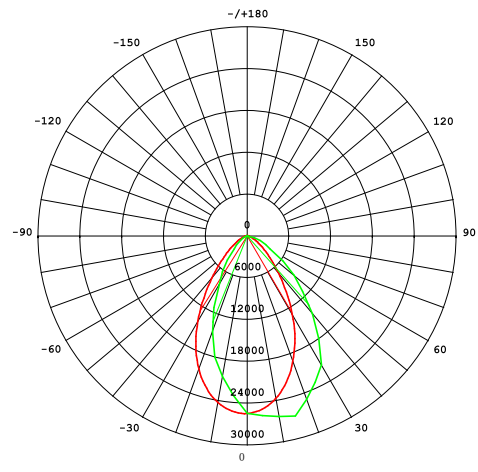

AVERAGE BEAM ANGLE(50%):63.2 DEG

UNIT:cd

- V 0.0DEG PLAN,62.6
- H 0.0DEG PLAN,63.8

90 Degree

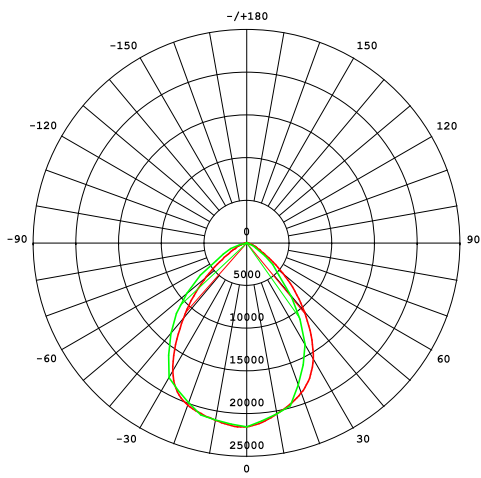

AVERAGE BEAM ANGLE(50%):81.6 DEG

UNIT:cd

- V 0.0DEG PLAN,81.0
- H 0.0DEG PLAN,82.1

120 Degree

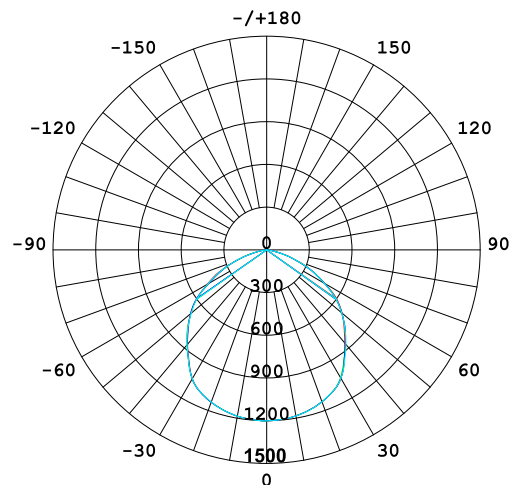

AVERAGE BEAM ANGLE(50%):109.6 DEG

UNIT:cd

- C0/180,110.0
- C30/210,109.4
- C60/240,109.6
- C90/270,109.4

Mounting Methods and Accessories

• Option 1: Ceiling Mounting

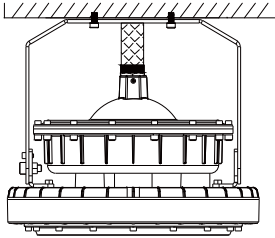

• Accessories



Bracket

Metal Conduit
EX-NG

• Option 2: Wall Mounting

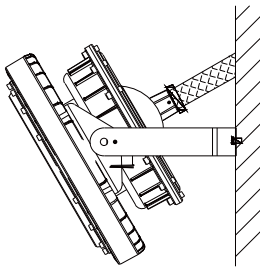

• Accessories



Bracket

Metal Conduit
EX-NG

• Option 3: Hook Pendant Mounting

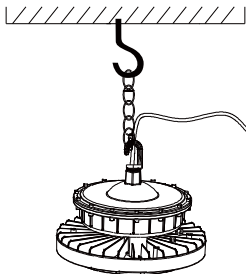

• Accessories



Hook
Ex-Hook

Pendant Chain
Ex-Straight Chain

• Option 4: Wall Mounting with Junction Box

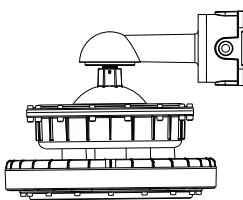

90 Degree

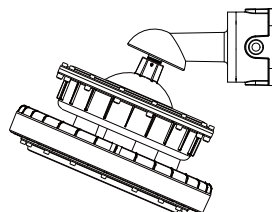

25 Degree

• Accessory



Stanchion Arm
EX-HD51-KYD 90

Stanchion Arm
EX-HD51-KYD 25

Mounting Methods and Accessories

- Option 5: Pole Mounting (Vertical)

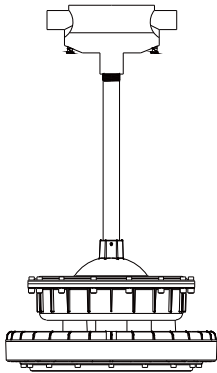

- Accessories



Junction Box
EX-HD51-KB1



Pole
Ex-Straight Pipe

- Option 6: Pole Mounting (Non-vertical)

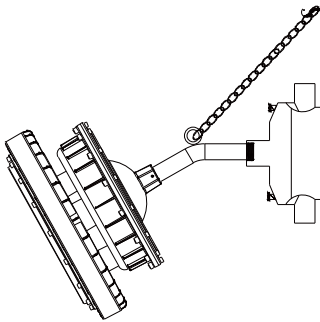

- Accessories



Junction Box
EX-HD51-KB1



Pole
Ex-Bended Pipe



Pendant Chain
Ex-Straight Chain

- Option 7: Trunnion Mounting (Only for C2)

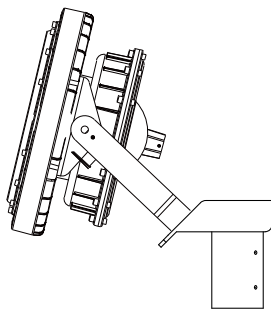

- Accessory



EX-Slip
Fitter Mounting Kit